

QualityPlastics

570 Fifth Street
 Prescott, Az. 86301
 928-445-2592 Fax:928-445-1518
 WWW.QUALITY-PLASTICS.COM

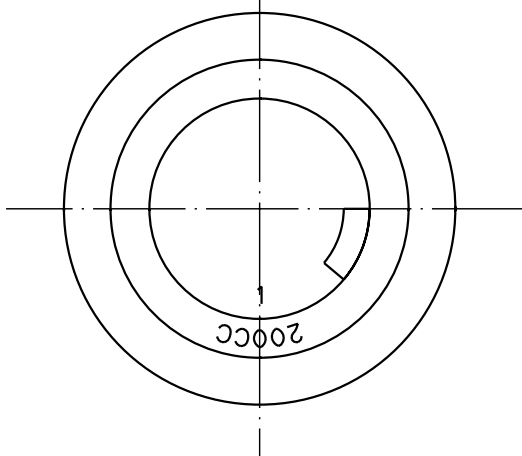

NECK DETAIL

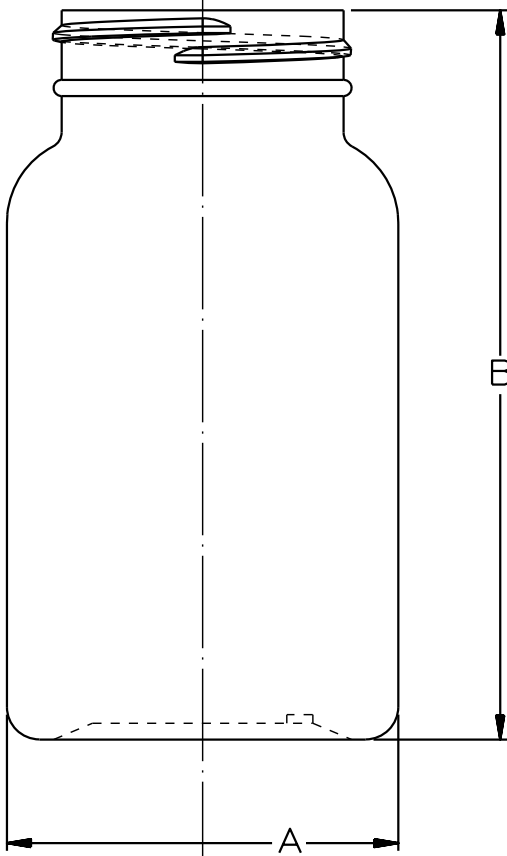
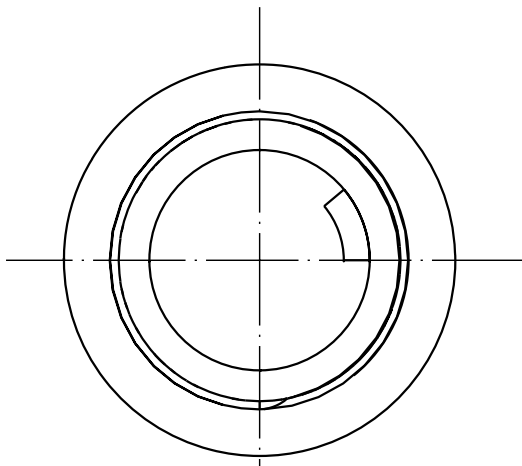
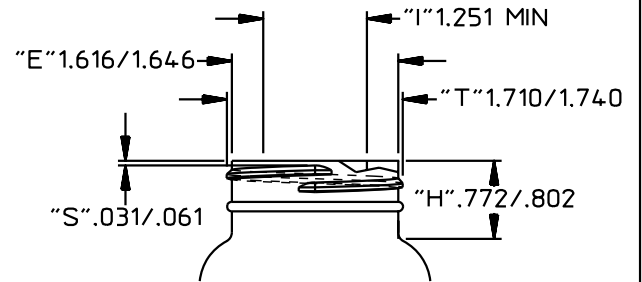

200cc Packer 45MM SPECIAL Drawing# 92-663-C

O.F.C.	217.6±6cc
WEIGHT	20g**
FINISH	45MM SPL
DIAMETER(A)	2.265±.062
HEIGHT(B)	4.220±.047
MAX LABEL(HEIGHT)	2.600
MAX LABEL(WIDTH)	N/A
PLUG FIT	USER SPECIFIED

SPECIAL WEIGHTS AVAILABLE UPON REQUEST

MANUFACTURED BY EXTRUSION BLOW MOLD
 DRAWING NOT TO SCALE