

QualityPlastics

570 Fifth Street
 Prescott, Az. 86301
 928-445-2592 Fax:928-445-1518
 WWW.QUALITY-PLASTICS.COM

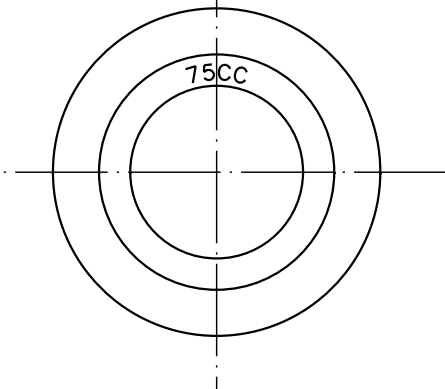

NECK DETAIL

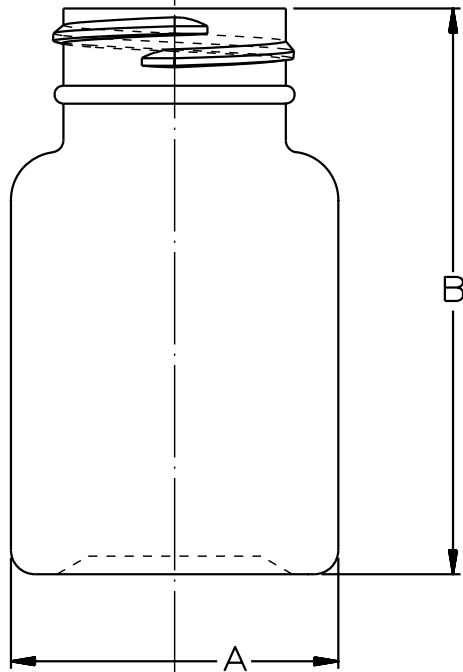
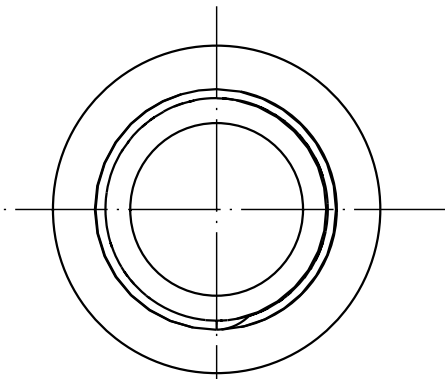
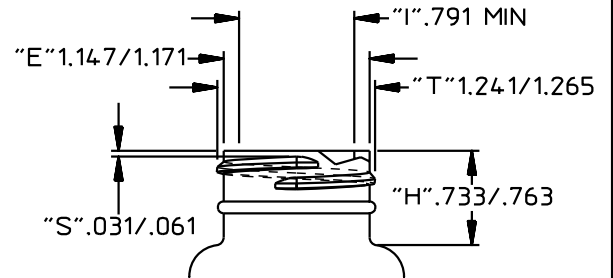

75cc Packer 33MM SPECIAL Drawing# 92-659-C

O.F.C.	83.6±4cc
WEIGHT	9.5g**
FINISH	33MM SPL
DIAMETER(A)	1.705±.047
HEIGHT(B)	2.947±.047
MAX LABEL(HEIGHT)	1.600
MAX LABEL(WIDTH)	N/A
PLUG FIT	USER SPECIFIED

SPECIAL WEIGHTS AVAILABLE UPON REQUEST

MANUFACTURED BY EXTRUSION BLOW MOLD
 DRAWING NOT TO SCALE